

ZM17 - Bracket 25mm 135deg

These brackets can be used to mount a modular camera. They are designed for modular cameras using an M20x1.5mm thread.

The bracket comes with three M20x1.5mm nuts.

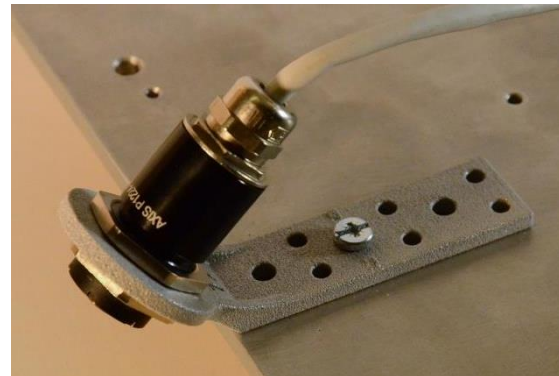
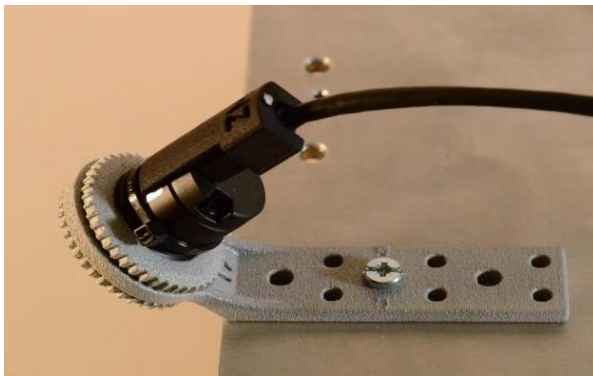
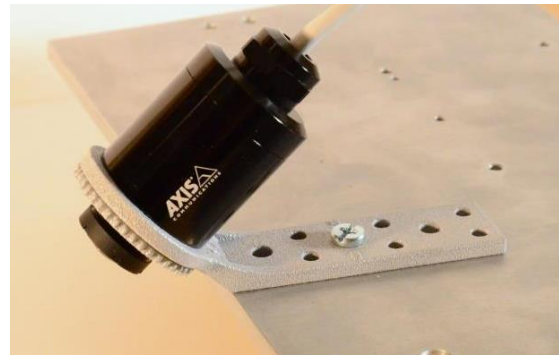
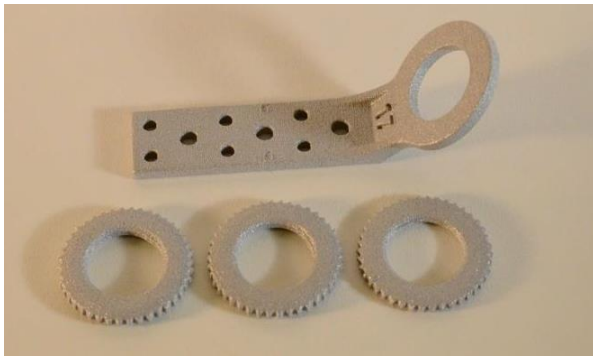

Order by using this link:

[ZM17 - Bracket 25mm, 135 deg](#)

The parts are intended for indoor use.

ZM17 - Bracket 25mm 135deg

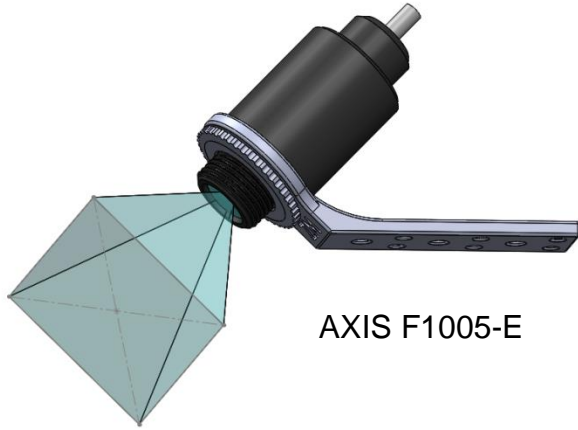

AXIS F1005-E

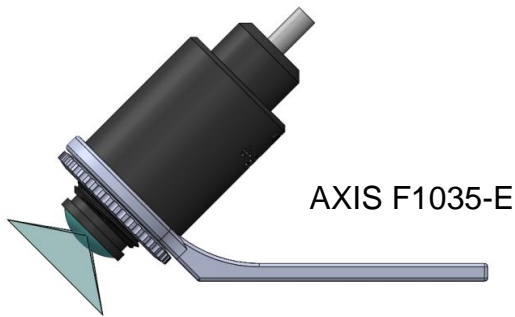
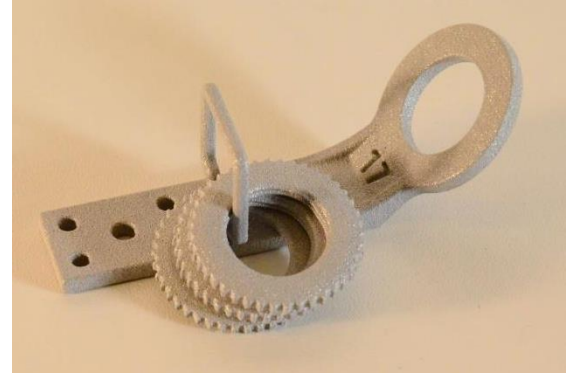

AXIS F1035-E

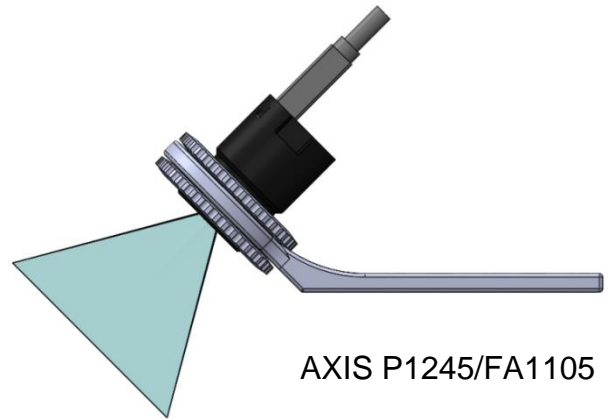

AXIS P1245/FA1105

